

INSTRUCTION SHEET

A

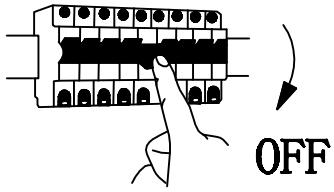

B

39131

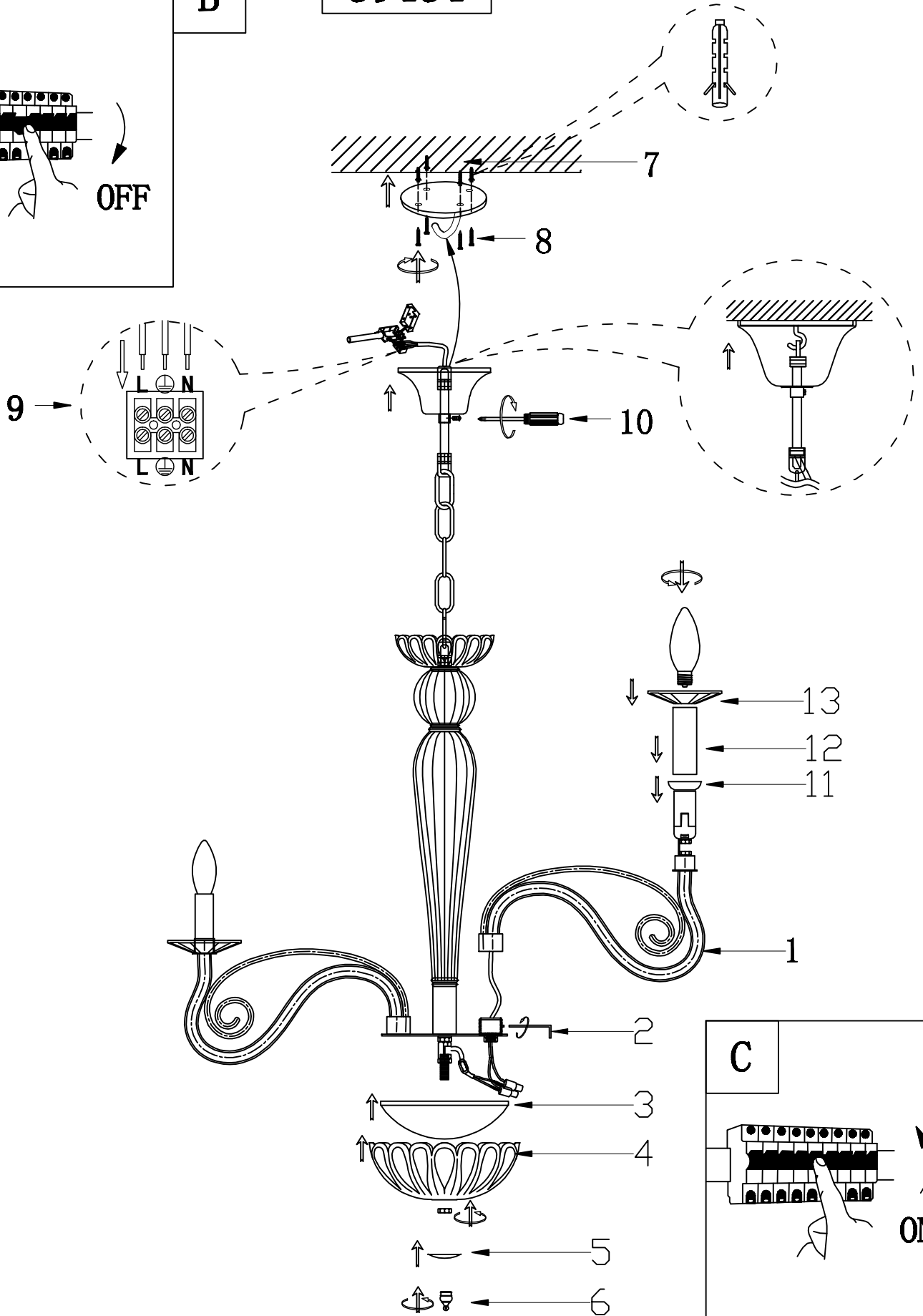

C

